

NIINO LAB.

New Function Through New Manufacturing Technology



Design-Led X Platform
Department of Mechanical and Biofunctional Systems

Additive Manufacturing Science

Department of Precision Engineering, Graduate School of Engineering

<http://lams.iis.u-tokyo.ac.jp>

Laboratory for additive manufacturing science, LAMS, performs studies on process and application technologies of additive manufacturing (3D printing), aiming at the creation of new mechatronic devices and systems through development of manufacturing technologies of fully 3-Dimensional and multi-material structures.

Research subjects

Additive manufacturing and laser sintering

Additive manufacturing is a process of joining materials to make parts or objects from 3D model data, usually layer upon layer, as opposed to subtractive manufacturing methodologies. Laser sintering is one of the additive manufacturing processes, which mainly involves spreading a thin layer of thermoplastic resin powder and repeatedly heating it with an infrared laser to selectively melt and solidify it to materialise the desired shape.

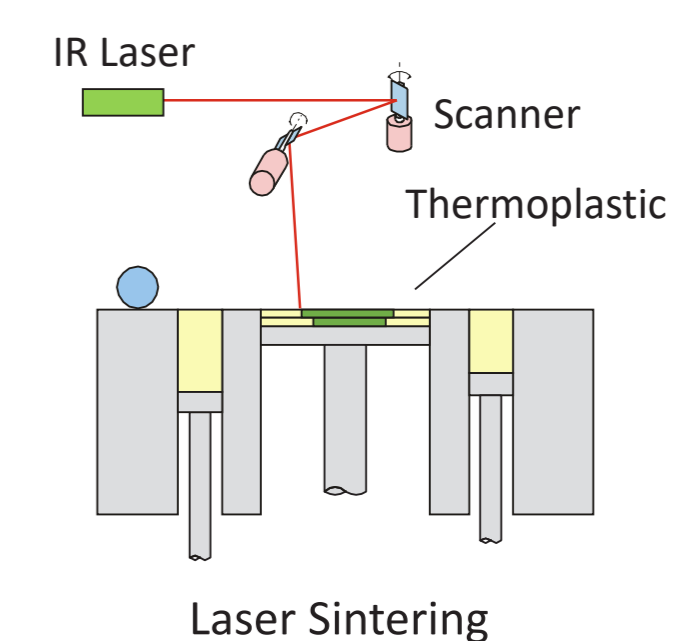

Laser Sintering

Research on Process Development

- Low Temperature Laser Sintering**
 Although powder bed preheating to near melting point effectively prevents warpage of workpieces during process, this method includes problems such as limitation of applicable material species and difficulty in reusing the powder leading to high material costs. 'Low-temperature laser sintering', where the preheating temperature can be freely selected eliminates these problems.
- Process for high performance plastics**
 Most of the high-performance plastics possess a high melting point, and it raises the requirement for heat resistance of processing machines leading to high machine cost as for conventional process. Removing this drawback, low temperature process facilitates provision of high-performance parts through laser sintering at a lower cost.
- Multi-material AM process**
 Few AM methods that can process multiple materials with very different melting points, such as resin and metal, in a single batch have been reported. An AM method of metal-resin composite structures is being researched by combining LDS (Laser Direct Structuring), one of the manufacturing technologies for MIDs (Molded Interconnect Devices) with laser sintering technology.

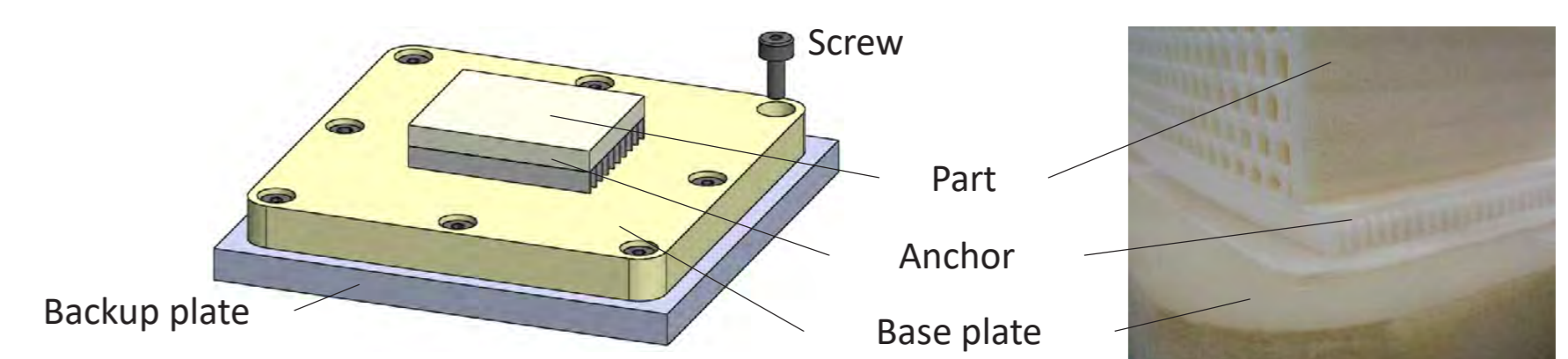

Low Temperature Laser Sintering

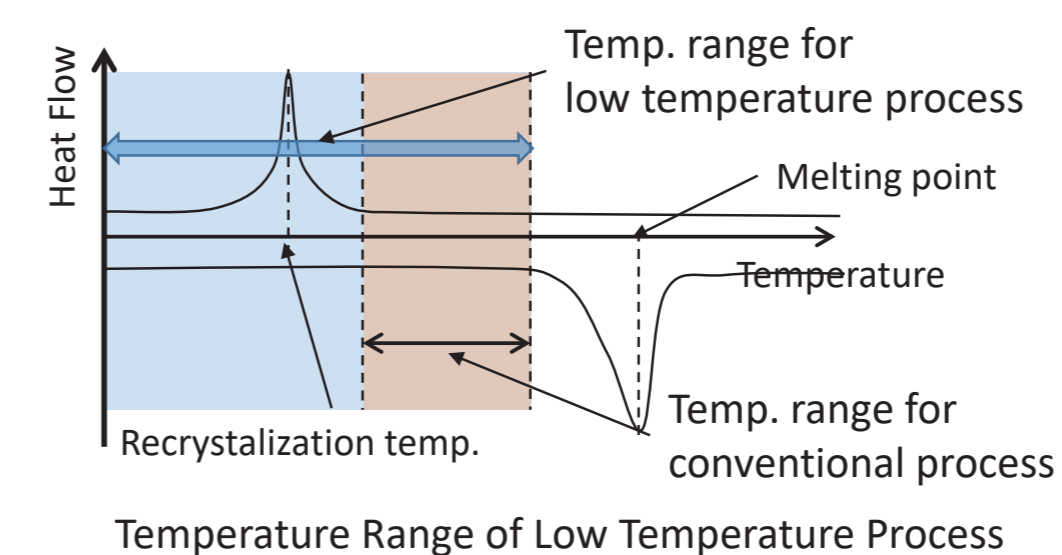

Parts out of PEEK

- Forming
- Activation
- Forming
- Plating

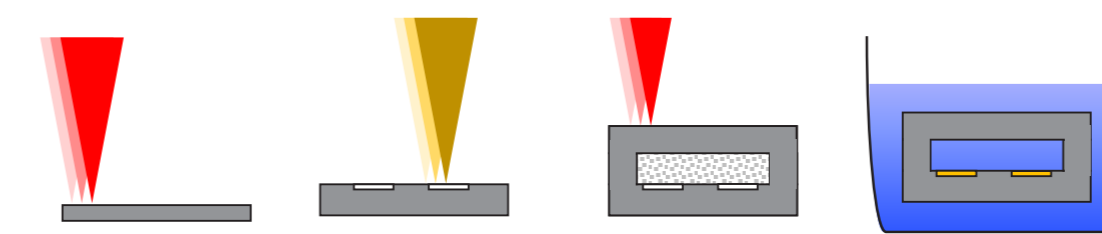

Process of Multi-material AM

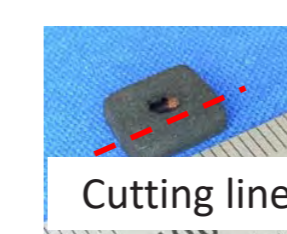

Copper Foil Structuring in Internal Hollow

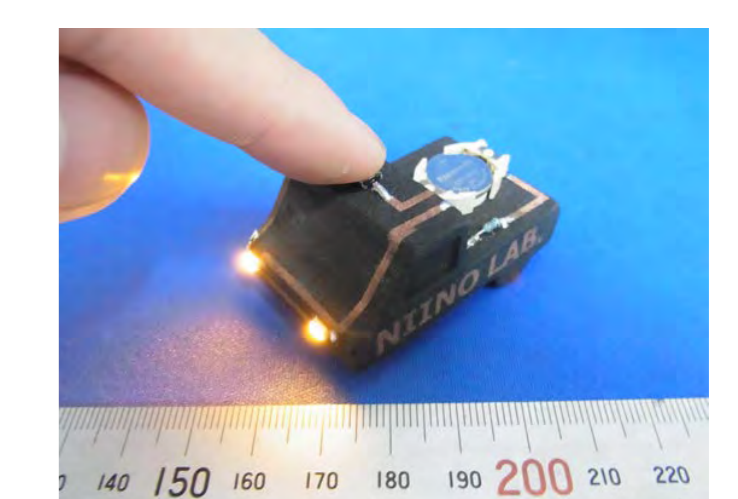

Parts having circuit

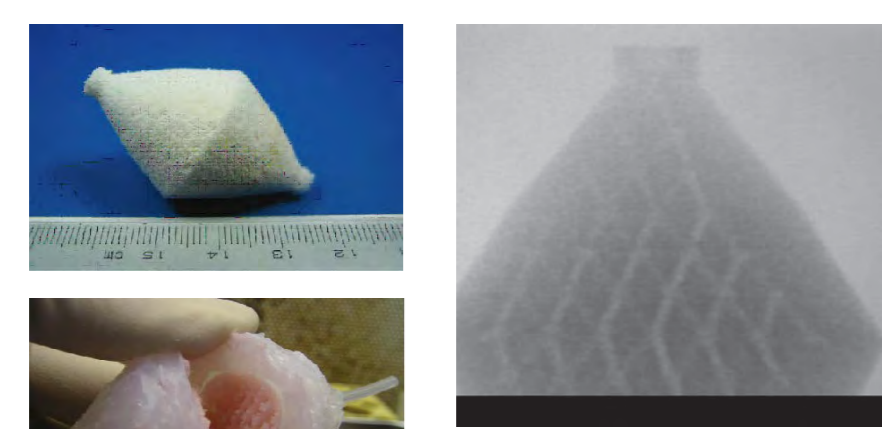

Tissue Engineering Scaffolds

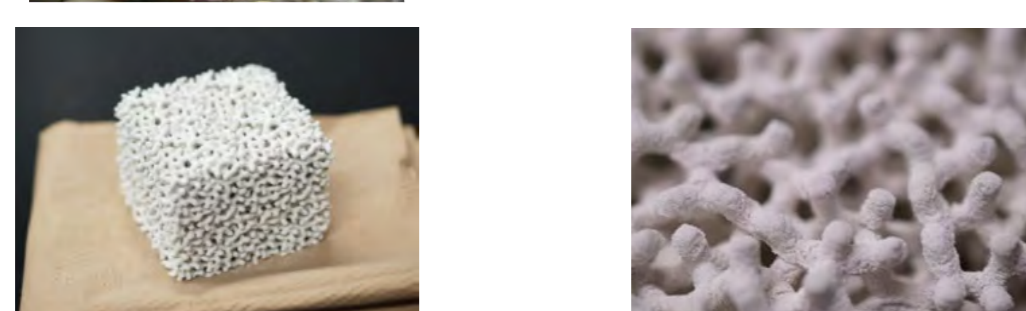

Optical device having diamond amorphous structure



Socket of PEEK

Labor time of technician

	Skilled	Mid-skilled	beginner
Conventional	4h05m	5h15m	7h15m
CAD	1h12m	1h30m	1h36m
Reduction	71%	71%	78%

Research on Application Development

- Additive manufacturing of tissue engineering scaffolds** (Collaboration with Sakai Lab. at FoE)
 Additive manufacturing has been utilized in various organ reconstruction methods in tissue engineering (regenerative medicine). Laser sintering of tissue engineering scaffolds made of biodegradable resin and cell culture using these scaffolds are being investigated for reconstruction of organs relatively large in scale and metabolic rates.
- Fabrication of optic devices** (Collaboration with Edagawa Lab. at Div. 1)
 In order to verify the theory proposed by Edagawa et al. (Div. 1, IIS) that high dielectric structures with an amorphous diamond structure have a band gap, amorphous diamond structures were actually produced by laser sintering a material containing titanium dioxide with high efficiency and the band gap was observed.
- Sport prosthesis through AM** (A national project, "New manufacturing through Additive Manufacturing").
 Proper utilization of AM requires comprehensive development of a business model, product selection, design and CAD tools suitable for AM. Using a sport prosthetic socket as an example, this project developed a trinity of processing technology for high-performance resin, functional and aesthetic design, and design tools for custom-made products in order to manufacture lightweight and high-strength prosthetic legs.

